

**Sorensen**

**Mi-BEAM Series**

**12 / 25 / 37 kW**

**0 to 2,000 V**

**±50 - ±150 A**

**Modular intelligent-Bidirectional Energy AMplified**

High Performance, Bidirectional, Regenerative,  
Programmable DC Power System

**Cal Power**

Via Acquanera, 29  
tel. 031.526.566 (r.a.)  
info@calpower.it

22100 COMO  
fax 031.507.984  
www.caltower.it

## Advanced Features

- Complete solution – battery test, simulation & solar array simulator software included
- Highest power density up to 37 kW in 4U rack height (9.25 kW/U)
- Fastest and cleanest power available
  - Fastest transient response
  - Low output ripple and noise
- Universal 3-Phase AC Input accepts 180 VAC to 528 VAC
- Longest manufacturer-based reliability guarantee, 5-year warranty
- Parallel system power up to 1.2 MW
- Output voltage up to 2,000 V
- Bidirectional output current up to ±150 A, up to ±4,800A in parallel
- True extended autoranging output
- Regenerative to 95%
- Color touch panel user interface
- Seamless transition between source and sink
- Built-in islanding detection



## Applications

- Battery simulation
- Battery testing (charge/discharge)
- Electric powertrain testing
- Fuel cell testing
- Solar inverter testing

## Performance. Power. Safety.

The Sorensen™ Modular Intelligent-Bidirectional Energy AMplified (Mi-BEAM) Series is the newest addition to the AMETEK Programmable Power portfolio of high-power testing solutions. The new Mi-BEAM Series features full DC source and sink capabilities with power levels from 12 kW up to 37 kW. The Mi-BEAM Series is fully scalable up to 1.2 MW with parallel systems. The available voltage ranges of 600V, 1,500V and 2,000VDC in a 4U rack height chassis provide full power up to 150A within a single system.

## Control via Front Panel Touchscreen and Digital or Analog Control Interfaces

The Mi-BEAM Series can be operated from the intuitive, front panel touchscreen that enables the user to easily setup, control and monitor the Output Programming Parameters, Supervisory and Set Point limits, Measurements, and System Settings. Additionally, a variety of standard communication control interfaces are available including; LAN, USB, RS-232, and Isolated Analog Programming and Monitoring. Optional IEEE-488 available.

### Featured Equipment Characteristics

- Standard modes of operation
- Bidirectional Mode (bi-DIR)
  - CV, CC, CP, Series Resistance (CV mode only), CV/CC, CC/CP, CV/CP, CV/CC/CP
- Source Mode (DC source only)
- Electronic Load Mode (eLoad)
  - Current, Power & Resistance Programming
- Battery Simulator Mode (BATSIM)
  - Charge/Discharge
- Battery Test Mode (BATTEST)
- Photo Voltaic Simulator Mode (PVSIM)
- Drive train testing with V-I characteristics for drive cycle tests
- Voltage/Current Ramps
- List/Waveform Generation
- Data Logging
- Remote Inhibits, Input/Output Triggers & Monitor Signals
- Firmware Updates via LAN
- Parallel Interface

### Communication & Control Interfaces

#### Standard Communication Interfaces

- LAN (10 BASE-T and 100 BASE-T)
- USB 2.0
- RS-232C
- Isolated Analog Programming & Monitoring
- SCPI Compliant Command Set
- IVI-C, IVI-COM and LabVIEW Drivers
- Virtual Panels GUI

#### Optional Communication Interfaces

- IEEE-488



## Specifications

The following sections provide electrical, environmental, and physical specifications for the Mi-BEAM DC Series power supplies.

Unless otherwise noted, the specifications are valid under the following conditions:

- Ambient temperature of  $25 \pm 5^{\circ}\text{C}$ , after a 30-minute warm-up, and at fixed AC input line and load.
- DC output into a resistive load.
- Specifications values are valid from 10% of the full-scale value.
- Stability is over an 8-hour period after a 30-minute warm up.
- If remote sense is used, then the output voltage accuracy, regulation and stability specifications are valid at the point where the remote sense leads are connected.

## Output Power

The Mi-BEAM features a universal 3-Phase AC Input that accepts Nominal 200 VAC to 480 VAC inputs with an overall range of 187 VAC to 528 VAC. Output power ratings are dependent on the 3-Phase AC Input Voltage.

Model	AC Input Voltage Nominal 380 – 480 VAC (Range 342 – 528 VAC)	AC Input Voltage Nominal 208 – 230 VAC (Range 187 – 253 VAC)
Mi-BEAM Series Output	12 kW, 25 kW, 37 kW	6 kW, 12 kW, 18 kW
When using the nominal Low Line Input range of 200 – 240 VAC the Output Power is derated to 50%.		

## Output Voltage and Current Ratings

Output voltage and current ratings are offered with Auto Ranging characteristics.

The Auto Ranging feature provides expanded current and voltage range at the full output power level, enabling the ability to satisfy a wider testing need without requiring the purchase of additional models.

Power	AC Input 342 – 528 VAC	12 kW	25 kW	37 kW
	AC Input 187 – 253 VAC	6 kW	12 kW	18 kW
Voltage (V)		Rated Current (A)		
600		50	100	150
1500		--	50	50
2000		--	50	50

## Auto Ranging Output Voltage and Current Characteristics

For the rated power ratings, the auto ranging models provide expanded current range enabling the ability to satisfy wider testing needs.

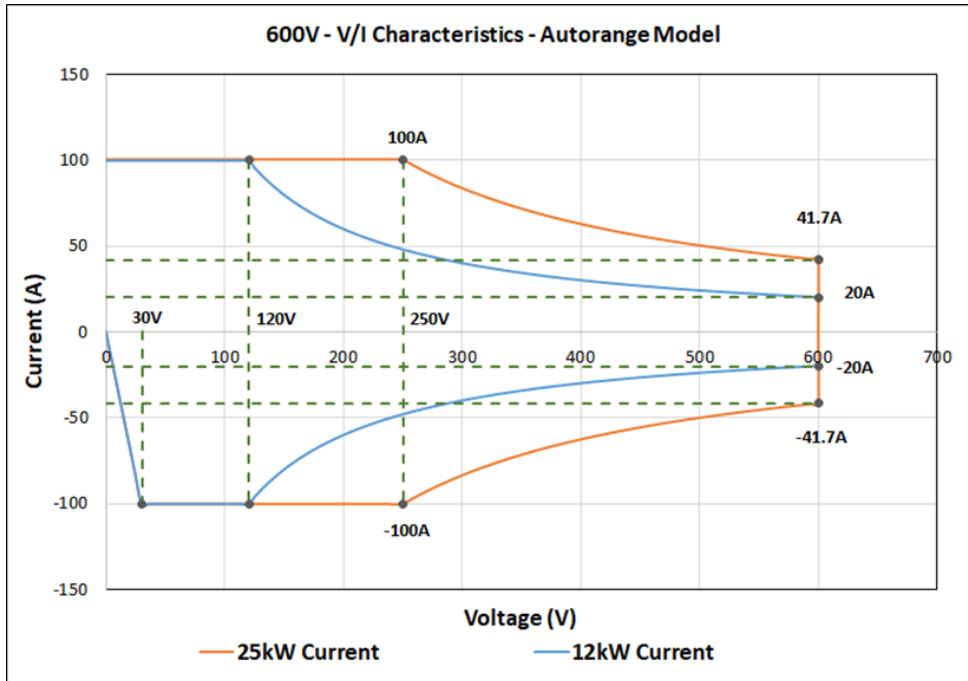
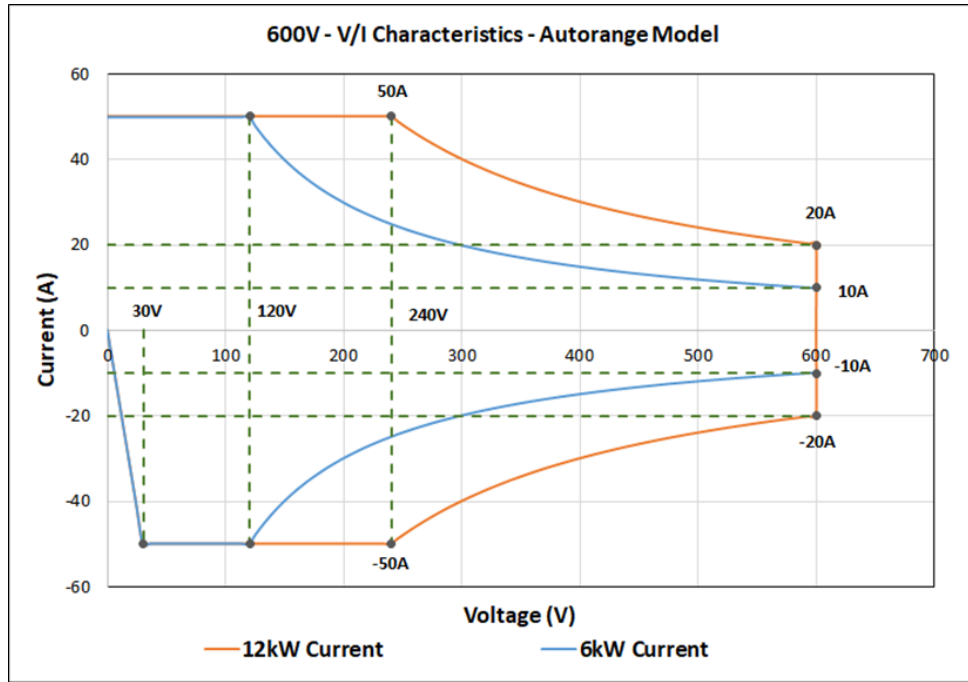

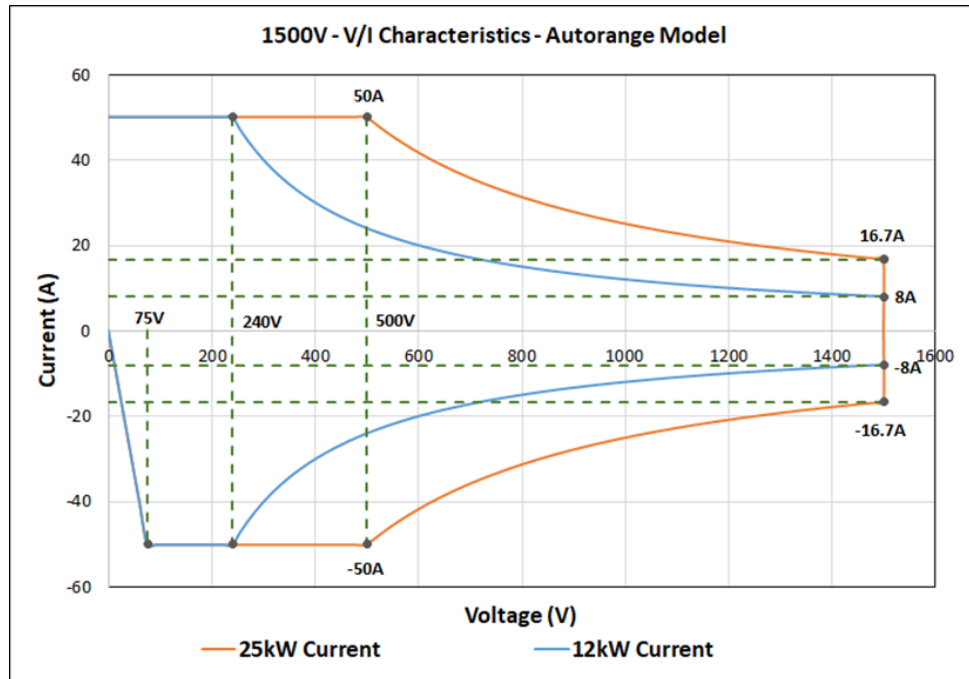
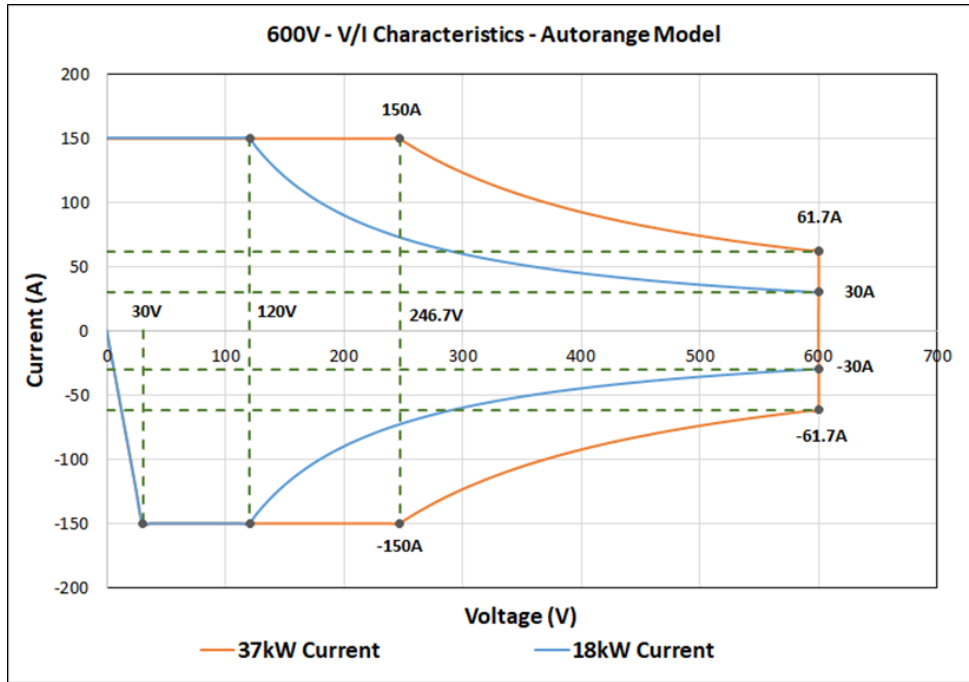

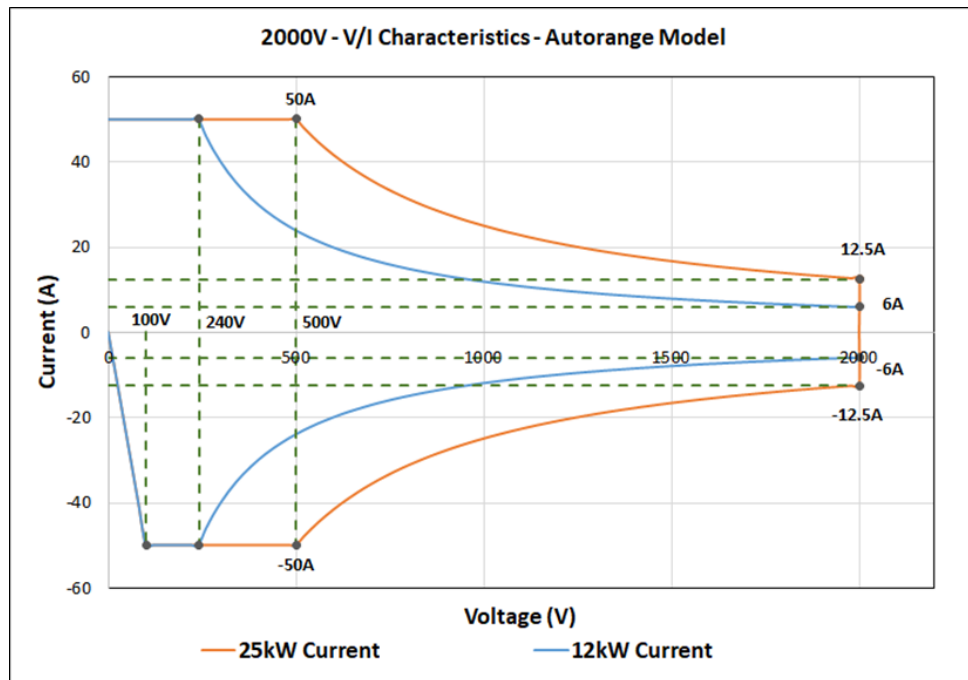
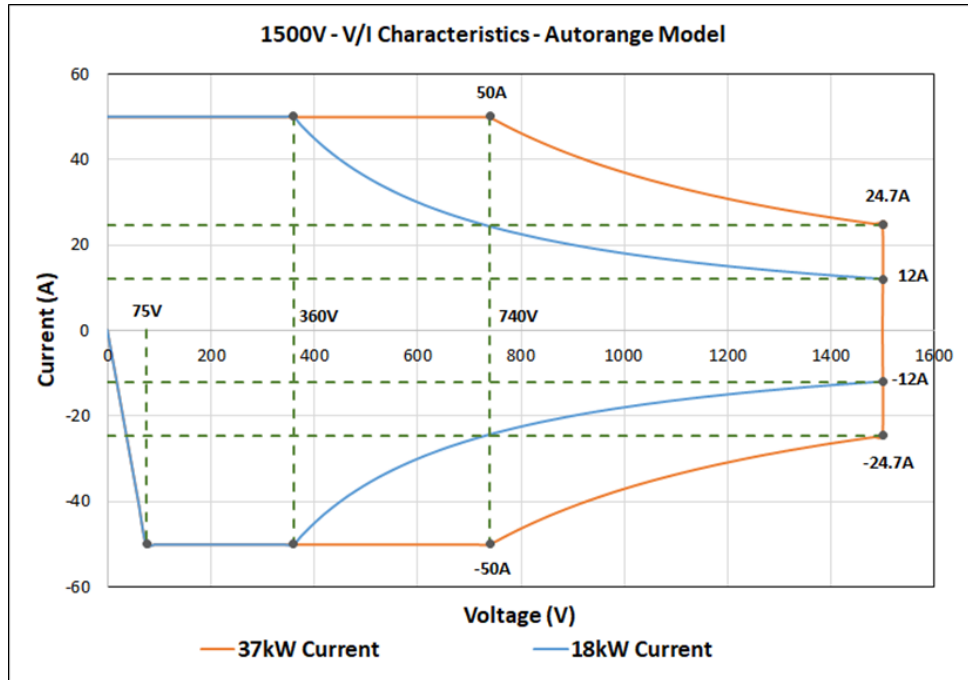

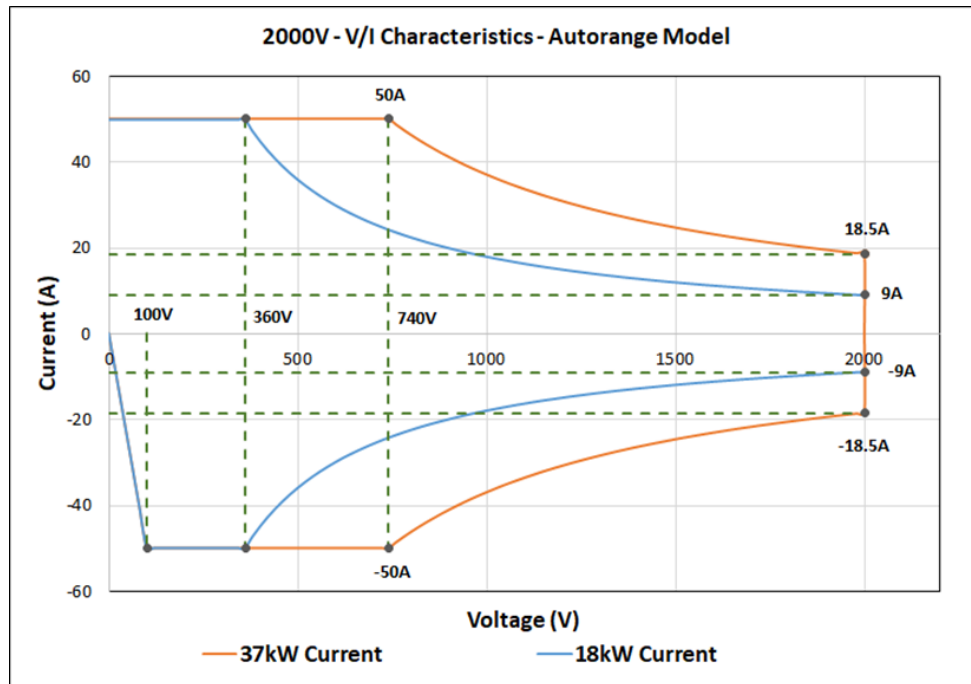

### Resolution Specifications

Resolution	Remote Digital Interface	Front Panel
Voltage output programming set resolution	0.002% of full scale	5 Digits
Current output programming set resolution	0.002% of full scale	5 Digits
Power output programming set resolution	0.01% of full scale	5 Digits
Overvoltage programming set resolution	0.1% of full scale	5 Digits
Voltage output readback set resolution	0.002% of full scale	5 Digits
Current output readback set resolution	0.002% of full scale	5 Digits
Power output readback set resolution	0.01% of full scale	5 Digits

**DC Output Programming, Readback and Regulation Specifications <sup>(1)(2)</sup>**

<b>Programming &amp; Readback Accuracy (via Front Panel or Remote Digital Interface)</b>	
Voltage output programming accuracy	+/- 0.1% of rated output voltage
Current output programming accuracy	+/- 0.4% of rated output current
Power output programming accuracy	+/- 0.75% of rated output power
Overvoltage programming accuracy	+/- 1%, maximum, of rated output voltage
Voltage output readback accuracy	+/- 0.1% of rated output voltage
Current output readback accuracy	+/- 0.4% of rated output current
Power output readback accuracy	+/- 0.75% of rated output current
Overvoltage response time	20 ms
<b>DC Regulation Characteristics – Constant Voltage (CV) Mode</b>	
Maximum line regulation	+/- 0.01% of rated voltage
Maximum load regulation	+/- 0.02% of rated voltage
Temperature Drift	+/- 0.02% of rated voltage
Stability	+/- 0.05% of rated voltage
<b>DC Regulation Characteristics – Constant Current (CC) Mode</b>	
Maximum line regulation	+/- 0.05% of rated voltage
Maximum load regulation	+/- 0.08% of rated voltage
Temperature Drift	+/- 0.03% of rated voltage
Stability	+/- 0.05% of rated voltage
<p>(1) Output voltage accuracy, regulation and stability specifications are valid at the point where the remote sense leads are connected. In the unit remote sense mode to be selected using front panel or the digital interface.</p> <p>(2) Regulation is measured with the rated power.</p>	

**eLoad Resistance Programming Range**

At a given operating voltage Minimum and Maximum resistance is determined as follows:

- Minimum resistance = Operating UUT Voltage / (Maximum current at the operating voltage)
- Maximum resistance = Operating UUT Voltage / (1.6% of rated current)

Power	AC Input 342 – 528 VAC	12 kW		25 kW		37 kW	
	AC Input 187 – 253 VAC	6 kW		12 kW		18 kW	
Voltage (V)	Minimum Operating Voltage for Maximum Current (V)	Min Res <sup>(1)</sup> (Ω)	Max Res <sup>(2)</sup> (Ω)	Min Res <sup>(1)</sup> (Ω)	Max Res <sup>(2)</sup> (Ω)	Min Res <sup>(1)</sup> (Ω)	Max Res <sup>(2)</sup> (Ω)
600	30	0.6	750	0.3	375	0.2	250
1500	75	--	--	1.5	1875	1.5	1875
2000	100	--	--	2	2500	2	2500
<p>(1) The minimum resistance value in this table is calculated at Minimum operating voltage. The minimum resistance value changes for each of the operating voltage and is calculated using the formula mentioned above.</p> <p>(2) The maximum resistance value in this table is calculated at Maximum operating voltage. The Maximum resistance value changes for each of the operating voltage and is calculated using the formula mentioned above.</p>							



Remote Sense Compensation	
Allowed Line Drop Voltage	2% of the rated output voltage
Connection	Voltage accuracy specifications apply at the point where the remote sense leads are connected.
Line Drop Effect on Output	There would be increased voltage equivalent to the line drop voltage at the terminals of the Power Supply.

Slew Rate Control Characteristics		
Models (V)	Voltage Regulation Operation <sup>(1)(2)</sup> (V/ms)	Current Regulation Operation <sup>(3)(4)</sup> (A/ms)
600	20	50
1500	50	25
2000	66	17

(1) Maximum rate of output voltage changes at rated load current.  
 (2) In voltage regulation mode the maximum slew rate of load current should not exceed specified maximum current slew rate.  
 (3) Maximum rate of output current change at rated output voltage.  
 (4) In current regulation mode the maximum slew rate of load voltage should not exceed specified maximum voltage slew rate.

Transient Specifications – Voltage Regulation Operation				
Model	Voltage Rise Time (ms), Full load <sup>(1)(3)</sup>	Voltage Fall Time (ms), Full load <sup>(2)(3)</sup>	Voltage Fall Time (ms), No load <sup>(4)</sup>	Transient response (ms) <sup>(5)(6)</sup>
600 V	30	30	50	1
1500 V	30	30	50	1
2000 V	30	30	50	1

(1) Measured from 10%-90% of the output voltage change at rated resistive load - typical.  
 (2) Measured from 90%-10% of the output voltage change at rated resistive load - typical.  
 (3) In voltage regulation mode the maximum slew rate of load current should not exceed specified maximum current slew rate.  
 (4) Measured from 90%-10% of output rated voltage at No load – typical  
 (5) Typical time to recover within 0.75% of rated output voltage for load change of 50-100% of rated output current.  
 (6) Typical overshoot and undershoot during the 50% load change would be within 10% of the rated voltage.

Transient Specifications – Current Regulation Operation			
Model	Current Rise Time (ms), Full load <sup>(1)(3)</sup>	Current Fall Time (ms), Full load <sup>(2)(3)</sup>	Transient response (ms) <sup>(4)(5)</sup>
600 V	1	1	0.5
1500 V	1	1	0.5
2000 V	1	1	0.5

(1) Measured from 10%-90% of the output current change at constant rated voltage regulated by UUT - typical.  
 (2) Measured from 90%-10% of the output current change at constant rated voltage regulated by UUT - typical.  
 (3) In current regulation mode the maximum slew rate of load voltage should not exceed specified maximum voltage slew rate.  
 (4) Typical time to recover within 0.75% of rated average output current for load change of 50-100% of rated output voltage.  
 (5) Typical overshoot and undershoot during the 50% output voltage change would be within 10% of the rated current.

Output Voltage Ripple and Noise (applicable to Voltage Regulation Operation)		
Rated Output Voltage (V)	Voltage Ripple & Noise RMS, mV <sup>(1)</sup>	Voltage Ripple & Noise PK-PK, mV <sup>(2)</sup>
600	120	500
1500	240	1000
2000	360	1500

(1) RMS ripple/noise, over 20 Hz to 300 kHz bandwidth, is measured directly across the output terminals with the supply operating into 90% of rated resistive load and nominal AC input line voltage.  
 (2) PK-PK ripple/noise, over 20 Hz to 20 MHz bandwidth with the supply operating into 90% of rated resistive load and nominal AC input line voltage.

AC Input Specifications	
Parameter	Description
<b>Universal 3-Phase Input Nominal Voltage Range</b>	200 – 240 VAC, 3 Phase, Line-Line 380 – 415 VAC, 3 Phase, Line-Line 440 – 480 VAC, 3 Phase, Line-Line
<b>Input Voltage, Operating Range (AC Input: 3 phase, 3 wire + Gnd)</b>	180 – 264 VAC, 3 Phase, Line-Line 342 – 456 VAC, 3 Phase, Line-Line 396 – 528 VAC, 3 Phase, Line-Line
<b>Input Current, Maximum RMS</b>	77 A at 180 VAC Line-Line 64 A at 342 VAC Line-Line 55 A at 396 VAC Line-Line
<b>Efficiency</b>	93%
<b>Inrush Current, Typical</b>	100 A
<b>Input Frequency, Nominal Rating</b>	50 Hz, 60 Hz
<b>Input Frequency Range</b>	47 Hz - 63 Hz
<b>Power Factor, Typical</b>	3-Ph: 0.99; active power factor controlled input rectifier
<b>Isolation Test Voltage</b>	1500 VAC Input to Ground

Operational Characteristics	
Parameter	Characteristic
<b>Bidirectional Mode</b>	In <b>bi-DIR Mode</b> the power can flow from power supply to UUT and vice versa (2 quadrant operation). The output current or voltage is regulated with these possible regulations: CV, CC, CP, CV/CC, CC/CP, CV/CP, and CV/CC/CP. Refer to operations manual for more details regarding regulation. There is also a series resistance mode, depending on the current output the terminal voltage would be varied depending on the voltage drop across the series resistance. If the output current reaches the programmed limit the output voltage is programmed to zero.
<b>Source Mode</b>	In <b>Source Mode</b> , the power can flow only from the power supply to UUT, the output current or voltage is regulated with these possible regulations: CV, CC, CP, CV/CC, CC/CP, CV/CP, and CV/CC/CP. Refer operations manual for more details regarding regulation. There is also a series resistance mode, depending on the current output the terminal voltage would be varied depending on the voltage drop across the series resistance. If the output current reaches the programmed limit the output voltage is programmed to zero.

Operational Characteristics	
Parameter	Characteristic
<b>eLoad Mode</b>	In <b>eLoad Mode</b> , power flow is from output of the power supply to the Input AC-Grid. In this mode, output voltage is regulated by the UUT, and the output current drawn by the supply from the UUT can be programmed in three possible types: Current Programming, Power Programming and Resistance Programming.
<b>Battery Simulation Mode</b>	In this mode, different battery characteristics can be simulated. The user can choose either from built in battery models of commonly used battery types or customized battery models. The required characteristics of charge and discharge operation can be fine-tuned using various battery parameters including the ability to import Voltage vs SOC data. Allows seamless dynamic transition from charge to discharge and vice versa.
<b>Battery Testing Mode</b>	In this mode, the required charge/discharge characteristics are applied to the UUT by the power supply. Users can create multiple charging and discharging profiles which can be sequenced to achieve the required battery test conditions. Allows seamless dynamic transition from charge to discharge and vice versa.
<b>Solar PV Array Simulator Mode</b>	In this mode, the PV curve of a solar array is applied by the power supply by operating in source-current mode to the UUT such as an inverter. PV array simulator simulates MPPT and various real-world PV array scenarios for testing the inverter. Includes EN50530 and Sandia SAS models.
<b>Automotive Standard Testing</b>	Pre-defined test sequences for partial compliance in accordance with LV 123 and LV 148 within the slew rate limitations specified for the supply. Tests such as injecting high frequency voltage ripple would require additional equipment.
<b>Drive Train Testing</b>	Drivetrains can be tested by operating the power supply in bi-DIR mode. The power supply is used to analyze the characteristics of the drive with the ability to regenerate power back to AC Grid during braking of the drive train. Includes V-I characteristics programming to support standardized drive cycle tests.
<b>Front Panel Controls</b>	Enhance front panel touch display for the unit enables control and programming of output.  Organized menus to support Output Programming, Measurements, Power on Settings, Communication Controls & System Settings, External Analog interface, Voltage and Current ramp functions.
<b>Voltage Ramp</b>	Voltage Ramps can be generated with a programmable Dwell, Start and End Voltage set points. Dwell time could be set to 1 ms minimum and 9999s maximum. Maximum slew to be limited as per the slew rate specifications of the output model.
<b>Current Ramp</b>	Current Ramps can be generated with a programmable Dwell, Start and End Current set points. Dwell time could be set to 1 ms minimum and 9999s maximum. Maximum slew to be limited as per the slew rate specifications of the output model.

Operational Characteristics	
Parameter	Characteristic
<b>List/ Waveform Generation Function</b>	The list function allows the user to set up the supply to automatically run a series of voltage, current and power mode operations. This is especially useful for setting up the supply to test to compliance standards or unburdening the test computer in automated testing applications. Through RS-232, IEEE-488 or Ethernet, an external computer can trigger the list. Up to 50 lists may be stored, with each list containing up to 50 individual steps. With an extensive list of step functions such as ramping and looping user can define a variety of test sequences.
<b>Fault Identification</b>	On-board diagnostics identify when power supply has experienced a fault.
<b>Programming Command Set</b>	SCPI compliant command set and same could be used using all the communication interfaces (USB, RS232, Ethernet, IEEE-488).
<b>Graphical User Interface (Virtual Panel)</b>	Virtual panels allow programming and monitoring of Mi-BEAM power supply remotely. GUI supports all the operational modes such as bi-Directional, Source, eLoad, Battery Simulation, Battery Test and Solar Array Simulation. It also supports Output Programming, Measurements, Power on Settings, Communication Controls & System Settings, External Analog interface, Voltage and Current ramp functions, List/Waveform generation function, Data Logging function.
<b>Software Drivers</b>	IVI-C and IVI-COM, LabVIEW drivers provided for user programming,
<b>GPIB interface, Option</b>	Parallel interface complies with IEEE-488.1, IEEE-488.2, and the SCPI command specification.
<b>Parallel Operation</b>	Similar rated channel chassis can be paralleled. Outputs to be hardwired to the load from the relevant paralleled output terminals. Up to 32 similar rated units can be paralleled.
<b>Analog Programming</b>	Provides Isolated Analog interface to program output.
<b>Calibration</b>	Calibration interval is 1 year; calibration is firmware-based through the SCPI commands using communication interface or Virtual Panels.
<sup>(1)</sup> Details of the operation modes can be found in the operation manual.	

Front Panel Controls and Indicators

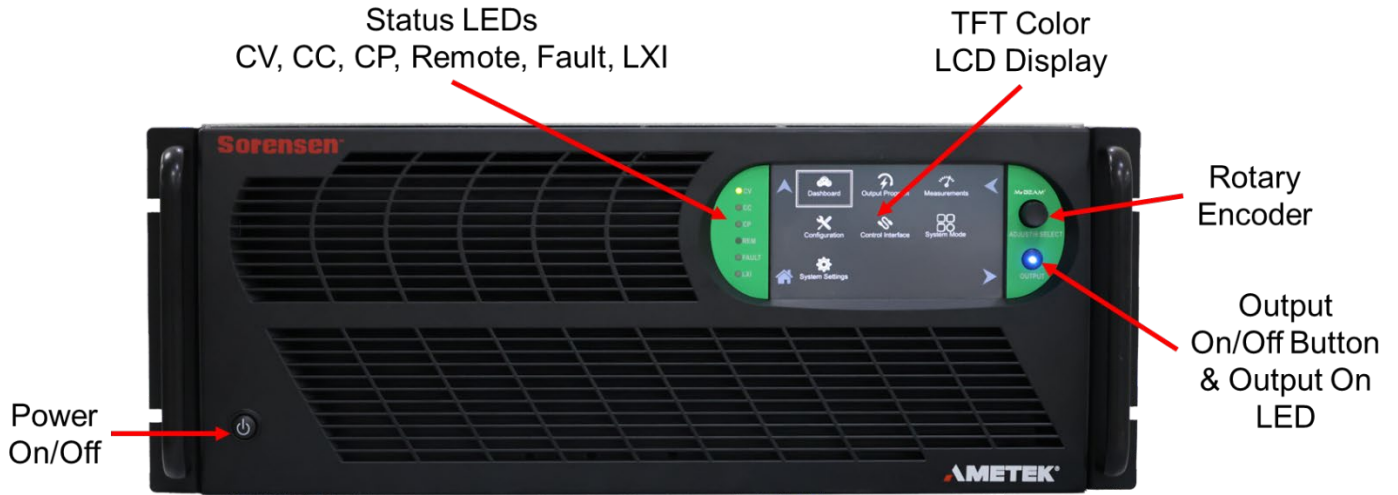

Rear Panel Connections

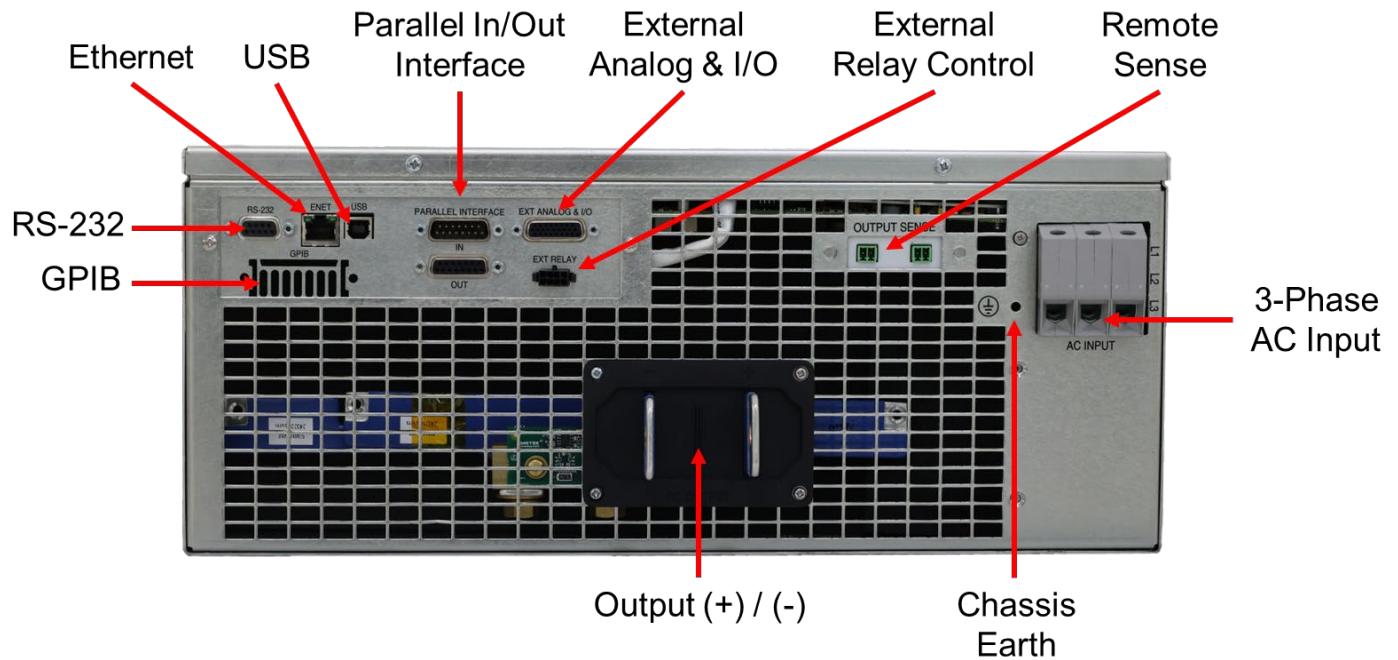

Remote Isolated External User Control I/O Signal Interface and Isolated Analog Interface	
Function	Characteristics
<b>Remote Inhibit Input – Contact Closure</b>	<p>Switch/Relay contact closure or direct short from this terminal to signal return is required to Turn ON the output of power supply. Opening the contact would shut down the output.</p> <p>Remote inhibit can be configured in three modes (LATCH, LIVE and OFF)</p> <p>Latch - after reclosing the contact, user needs to clear the fault and turn ON the output.</p> <p>Live - after reclosing the contact, user needs to turn ON the output.</p> <p>OFF – inhibit function would be disabled.</p> <p>Remote circuit must sink up to 10 mA from 5 VDC to enable.</p>
<b>Remote Inhibit Input – Active Source</b>	<p>An active voltage source from this terminal to signal return is required to Turn OFF the output of power supply.</p> <p>Remote inhibit can be configured in three modes (LATCH, LIVE and OFF)</p> <p>Latch - after removing the active voltage source, user needs to clear the fault and turn ON the output.</p> <p>Live - after removing the active voltage source, user needs to turn ON the output.</p> <p>OFF – inhibit function would be disabled.</p> <p>Remote circuit must sink up to 10 mA from 5 VDC to enable.</p>
<b>Trigger In</b>	<p>TTL compatible Input signal, active-high pulse of 10 ms; provides external hardware trigger at falling edge of the pulse for voltage, current ramp and sequencing functions. Signal connects to Open-anode of opto-isolator diode with internal 1 kΩ series resistor internal to power supply.</p> <p>Voltage Rating: Maximum 24 V, Minimum -5 V</p> <p>Low state: 0.3 V max, High State 2.7 V min</p>
<b>Trigger Out</b>	<p>Output signal, active-high; synchronization pulse of 10 ms when a change in the output occurs.</p> <p>Open collector transistor output, Collector is connected to the 26-pin connector. Emitter point of transistor is connected to common return pin of the interface connector.</p> <p>Voltage Rating: Maximum 30 V, Minimum 3 V for Active High, Current Sink Current: 50 mA</p>

Remote Isolated External User Control I/O Signal Interface and Isolated Analog Interface	
Function	Characteristics
<b>CC/CV Status Output</b>	<p>Output signal, High state indicates Constant Current mode operation and Low state indicates Constant Voltage mode operation.</p> <p>Open collector transistor output, Collector is connected the 26-pin connector. Emitter point of transistor is connected to common return pin of the interface connector.</p> <p>Voltage Rating: Maximum 30 V, Minimum 3 V for Active High, Current Sink Current: 50 mA</p>
<b>Output ON/OFF Status</b>	<p>Output signal, High state indicates Output is ON and Low state indicates Output is OFF.</p> <p>Open collector transistor output, Collector is connected the 26-pin connector. The emitter point of transistor is connected to the common return pin of the interface connector.</p> <p>Voltage Rating: Maximum 30 V, Minimum 3 V for Active High, Sink Current: 50 mA</p>
<b>FAULT Status</b>	<p>Output Signal, High state indicates fault state of the power supply.</p> <p>Open collector transistor output, Collector is connected the 26-pin connector. The emitter point of transistor is connected to the common return pin of the interface connector.</p> <p>Voltage Rating: Maximum 30 V, Minimum 3 V for Active High, Current Sink Current: 50 mA</p>
Isolated Analog Programming Features	
Function	Characteristics
<b>Remote Analog Programming of Output Voltage <sup>(1)</sup></b>	<p>Independent Signal inputs for output voltage programming using External Analog Reference.</p> <p>Analog reference source is user selectable and can be a voltage or resistance. Selected analog reference source can be used to program output voltage.</p> <p><b>Voltage as Reference Source:</b> 0 V to user selectable maximum range (5 V to 10 V) for 0 to full scale rated Output.</p> <p><b>Resistance as Reference Source:</b> 0 <math>\Omega</math> to user selectable maximum range (5 k<math>\Omega</math> to 10 k<math>\Omega</math>) for 0 to full scale rated Output.</p> <p>Programming accuracy and linearity: <math>\pm 1\%</math> of rated output</p>



Remote Isolated External User Control I/O Signal Interface and Isolated Analog Interface	
Function	Characteristics
<b>Remote Analog Programming of Output Current</b> <sup>(1)</sup>	<p>Independent Signal inputs for output current programming using External Analog Reference.</p> <p>Analog reference source is user selectable and can be a voltage or resistance. Selected analog reference source can be used to program output current.</p> <p><b>Voltage as Reference Source:</b> User selectable range of (-5 V to +5 V) or (-10 V to +10 V) for 0 to full scale rated Output.</p> <p><b>Resistance as Reference Source:</b> 0 <math>\Omega</math> to user selectable maximum range (5 k<math>\Omega</math> to 10 k<math>\Omega</math>) for 0 to full scale rated Output. This is applicable in source mode only.</p> <p>Programming accuracy and linearity: <math>\pm 1\%</math> of rated output</p>
<b>Monitor Signals for the Output Voltage and Output Current</b>	<p>Monitor Signals for the Output Voltage and Current.</p> <p>Full Scale range: 0 V to 10 V corresponds to 0-100% full-scale output.</p> <p>Minimum recommended Load: 100 k<math>\Omega</math>, typical</p> <p>Maximum Load: 20 k<math>\Omega</math></p> <p>Monitor accuracy and linearity: <math>\pm 1\%</math> of full-scale output</p>
<b>Remote Analog Programming of Overvoltage</b> <sup>(1)</sup>	<p>Signal input for setting Overvoltage using External Analog Reference Voltage.</p> <p>Range: 0.25 V to user selectable maximum range (5 V to 10 V) for 5% to 110% of the full-scale Output Voltage.</p> <p>Programming accuracy and linearity: <math>\pm 1\%</math> of full-scale output</p>
<sup>(1)</sup> Remote analog programming is not applicable for battery test, battery simulator and PV simulator operating modes	

Remote Control Digital Interface Characteristics	
Interface	Characteristic
<b>LAN</b>	<p>Ethernet LXI Complaint 10BASE-T and 100BASE-T over twisted-pair cables compliant with IEEE 802.3;</p> <p>Connector: 8P8C modular jack.</p>
<b>USB</b>	<p>Serial interface compliant to USB 2.0;</p> <p>Connector: Type-B receptacle.</p>
<b>RS-232C</b>	<p>Serial interface compliant to RS-232C;</p> <p>Protocol: data bits, 7 with parity and 8 without parity; stop bits, 2; baud rate, 9600 to 115200; handshake, CTS and RTS;</p> <p>Connector: Subminiature-D, 9-contact receptacle.</p>

Remote Control Digital Interface Characteristics	
Interface	Characteristic
IEEE-488 (Optional)	Parallel interface complies with IEEE-488.1, IEEE-488.2, and the SCPI command specification; Command execution response time, 10 ms, typical; Connector: IEEE-488.1 compliant.
Firmware Upgrade	Firmware could be upgraded through the LAN interface and a Command Line Firmware Update Tool.

Protection Functions	
Function	Characteristics
Output Overvoltage Protection (OVP)	Programmable to 110% of full-scale output voltage; exceeding OVP threshold results in shutdown of output.
Output Current Limit Protection	User-selectable fold back mode CV/CC/CP or CV or CC or CP. In CV/CC/CP mode, output current or power is regulated to setpoint on reaching limit. In CV mode, reaching current or power limits results in shutdown of output. In CC mode, reaching voltage or power limits results in shutdown of output. In CP mode, reaching voltage or current limits results in shutdown of output. In CV or CC or CP mode, shutdown delay on reaching the limit is programmable from 100 ms to 5 s.
AC Input Overcurrent Protection	Internal fuses in each phase for fault isolation; not user replaceable
AC Input Undervoltage Protection	Automatic shutdown for insufficient AC input voltage
Islanding Detection	In sink mode, the loss of input AC grid is detected by built-in islanding detection feature. Thus, accidental islanding formation with the regenerative load is avoided.
AC Input Transient Protection	Protection to withstand EN61326-1, Surge testing to industrial test levels
Overtemperature Protection (OTP)	Internal temperature monitors cause shutdown of output if temperature thresholds are exceeded

Output Isolation	
Parameter	Isolation
	600 V < Output Voltage ≤ 2000 V
Output terminal Chassis Earth <sup>(1)</sup>	1430 VRMS / ±2000 V <sub>peak</sub>
Output terminal Positive to (+Ve) to Negative (-Ve)	V <sub>peak</sub> = 110% of output rated voltage
Isolated Analog interface Signals and External User Control I/O interface to Output Negative terminal	±2000 V <sub>peak</sub> , maximum; Isolated Analog programming and external user interface signals are galvanically isolated from negative output terminal; operation of Isolated Analog Interface signals should be at SELV safety voltage conditions to chassis ground.
<sup>(1)</sup> The output terminal positive to chassis earth voltage is the sum of the output terminal negative to chassis earth voltage and operating output voltage. At any operating condition, the output terminals to chassis earth voltage should not exceed the given limit.	

Environmental Specifications	
Parameter	Specification
Operating Temperature	0°C to +40°C (+32°F to +104°F)
Storage Temperature	-25°C to 65°C (-13°F to +149°F)
Altitude	2000 m (6,600 ft)
Operating Humidity	20-90 %, non-condensing
Relative Humidity	10-95 %, non-condensing
Vibration	MIL-PRF-28800F, Class 3; 5-500 Hz per Paragraph 4.5.5.3.1.
Shock	MIL-PRF-28800F, Class 3; 30G half-sine with 11 ms duration per Paragraph 4.5.5.4.1.
Transportation Integrity	ISTA Test Procedure 1B

Regulatory Agency Compliance	
Parameter	Specification
<b>EMC</b>	CE marked for EMC Directive 2014/30/EU per EN61326-1:2013, Class-A for emissions and immunity as required.
<b>Safety</b>	NRTL marked for US and Canada to CAN/CSA-C22.2 No. 61010-1-12, UL 61010-1 Third Edition. CE marked for LVD compliance 2014/35/EU to EN 61010-1 Third Edition as required for the EU CE mark.
<b>CE Mark LVD Categories</b>	Installation Overvoltage Category: II; Pollution Degree: 2 Indoor use only.
<b>RoHS</b>	CE marked for compliance with RoHS3 EU Directive 2015/863/EU for Restriction of Hazardous Substances in Electrical and Electronic Equipment.

Mechanical Specifications	
Parameter	Specification
<b>Dimensions</b>	H, 6.97" (177 mm); W (front panel), 18.9" (480 mm); D, 27.56" (700 mm-enclosure only); H, 6.97" (177 mm); W (Chassis), 16.9" (429 mm); D, 27.56" (700 mm- enclosure only);
<b>Unit Weight</b>	12 kW: 99.2 lbs. (45 kg) 25 kW: 123.5 lbs. (56 kg) 37 kW: 147.7 lbs. (67 kg)
<b>Shipping Weight</b>	Add Approx. 15 lbs. (6.8 kg) to unit weights
<b>Chassis Material</b>	Steel with plastic front panel
<b>Chassis Finish</b>	Steel electroplated
<b>Installation</b>	Protective covers are provided for AC input and DC output; Rackmount: per ANSI-EIA-310-D, with front panel mounting flanges and chassis provisions for mounting rack slides; slides option available.
<b>Cooling</b>	Force-air cooling; linear, variable fan speed control; air intake at front/sides and exhaust at rear.
<b>Acoustic Noise</b>	61 dBA, at idle fan speed; measured at 1 m with A-weighting; 76 dBA, at maximum fan speed; measured at 1 m with A-weighting;

### External Relay Control Signal Connector

The Mi-BEAM Series includes an 8-pin interface connector to control user supplied external relays. The signals POLARITY, ISOLATION AND SENSE are used to reverse the output polarity. The EXTERNAL signal is used as user programmable relay . Refer to operation manual for details.

Function	Characteristics
<b>POLARITY</b>	Output signal, asserted when negative output polarity is programmed.
<b>ISOLATION</b>	Output signal, asserted when the output isolation relay is programmed ON.
<b>SENSE</b>	Output signal, asserted when the sense relay is programmed ON.
<b>EXTERNAL</b>	Output signal, asserted when the external relay is programmed ON.

### Order Information:

#### Model Number Description:

Voltage	Power	Current
600 V	12 kW	50 A
600 V	25 kW	100 A
600 V	37 kW	150 A
1500 V	25 kW	50 A
1500 V	37 kW	50 A
2000 V	25 kW	50 A
2000 V	37 kW	50 A

#### Mi-BEAM Model Description

**MIB-VVVV-PP-CCCC-AA**

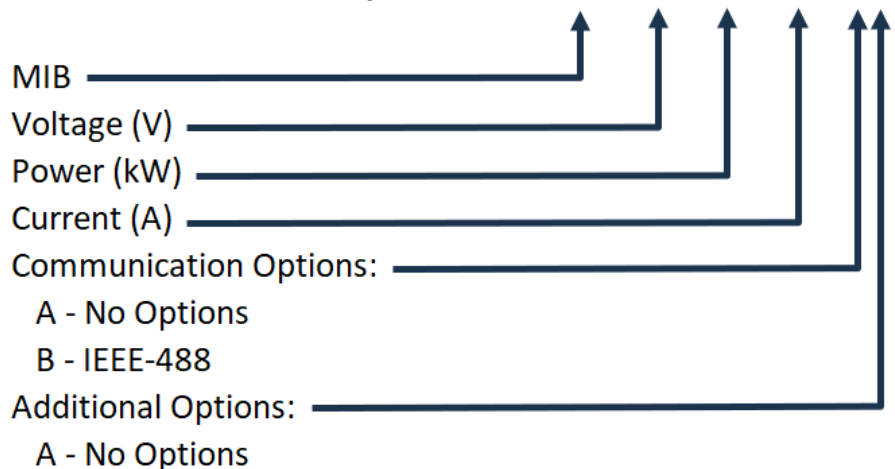

Note: The Mi-BEAM has a Universal 3-Phase AC Input to accept 200VAC to 480VAC (Range 180VAC to 528VAC).

AC Input Voltages of 200VAC to 240VAC (Range 180VAC to 264VAC) will derate the output power 50%.

- 12kW reduced to 6kW
- 25kW reduced to 12kW
- 37kw reduced to 18kW

### Model Number Example:

MIB-2000-37-0050-AA = Mi-BEAM, 2000 V Output, 37 kW, 50 A Output, No Options

**Cal Power**

Via Acquanera, 29 22100 COMO  
tel. 031.526.566 (r.a.) fax 031.507.984  
[info@calpower.it](mailto:info@calpower.it) [www.calpower.it](http://www.calpower.it)

**Warranty Statement:**

AMETEK Programmable Power Inc. warrants its products to be free from defects in material and workmanship. The warranty period is from the date of original shipment of the product to the original purchaser (see website for warranty periods by product). The Mi-BEAM Series comes with a **Five (5)** year warranty.

Note: All specifications subject to change without notice.